

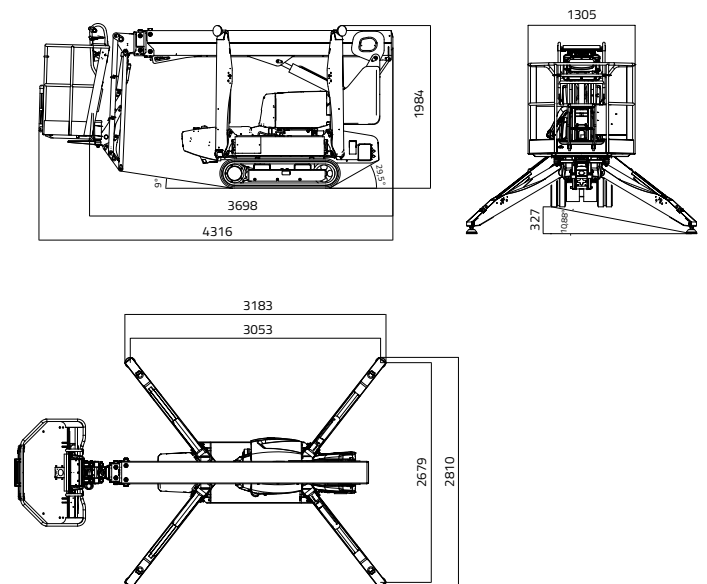













Capacity 230 kg
(2 persons 80x2=160 kg + toolbox 70 kg)



	12,90 m
	6,40 m
	4,316 m
	3,698 m
	1,948 m
	748 - 1100 mm
	1480x610xh.1100 mm

	16°
	2050 kg / 4520 lb
	3053 x 2679 mm
	Automatic set up system IIS std
	Remote control
	GPRS-GPS
	R.A.H.M.



Battery52V 80Ah
Electric motor :
- rated voltage48 V
- rated power2 kW
Onboard battery charger:
110V-230V+-30V 50-60 Hz