



ELECTRIC SCISSOR LIFT

AS1413E (AS4650E)

HIGHLIGHTS

With a platform height of 13.8m, the LGMG AS1413E greatly expands the working height of electric scissor lifts and improves the productivity for the operators in high applications.

- Efficient AC motor drive system provides longer lasting performance and better gradeability.
- 320kg capacity with 0.9m extension deck offers great productivity.
- Battery powered, zero emission and quiet drive mean this machine is environmentally friendly.
- Forklift pockets on both side and rear position for easy handling.
- Swing out component trays for easy access and maintenance.
- Intelligent self-diagnostic system for quick troubleshooting.



LGMG Electric Motor Drive Scissor Lift

SPECIFICATIONS

MODELS		AS1413E (AS4650E)	
Measurements	Metric	US	
Working Height Max. (Indoor/Outdoor)	15.8/10m	51.8/32.8ft	
A Platform Height-Raised (Indoor/Outdoor)	13.8/8m	45.3/26.2ft	
B Platform Height-Stowed	1.57m	5.15ft	
C Platform Length	2.64m	8.7ft	
D Platform Width	1.12m	3.67ft	
E Overall Length (with ladder)	2.8m	9.2ft	
F Overall Width	1.3m	4.3ft	
G Overall Height-Rails Up	2.74m	9ft	
Overall Height-Rails Down	1.94m	6.4ft	
H Extension Deck	0.9m	3ft	
I Wheelbase	2.22m	87.4in	
Ground Clearance(Stowed/Raised)	105/20mm	4.1/0.79in	
PRODUCTIVITY			
Platform Occupants Max. (in/out)	2/1	2/1	
Platform Capacity	320kg	705lbs	
Platform Capacity-Extension	120kg	265lbs	
Drive Height		Full Height	
Gradeability-Stowed		25 %	
Turning Radius-Inside		0	
Turning Radius-Outside	2.6m	8.5ft	
Raise/Lower Speed		85/65 s	
Brakes		Front-wheel Brake	
Drive Mode		4×2	
Tires Type		Solid Non-marking	
Tires Size	380×130mm	15×5 in	
POWER			
Power Source		24V DC 300Ah	
HYDRAULIC SYSTEM			
Hydraulic Oil Capacity	25.5L	6.7gal	
WEIGHT			
Machine Weight(CE/ANSI)	3570kg	7870lbs	

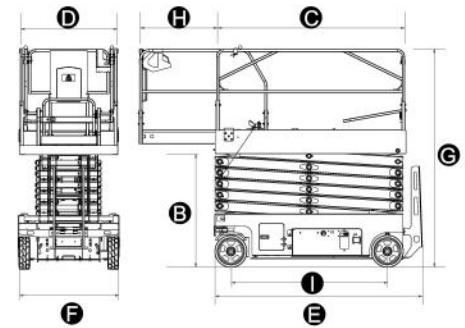

STANDARD FEATURES

- Proportional control
- Foldable guardrails
- Emergency stop device
- Manual brake release
- Emergency descent
- Swing-out component trays
- Pothole guards
- Self-lock entry gates
- Tilt alarm with lift cut-out
- Overload sensing system
- Descent alarm with flashing beacons
- Horn/Hour meter
- All motions alarm
- Full-height drive*
- Intelligent diagnostic system

OPTIONAL

- AC power to platform
- Platform anti-collision device
- Air tube to platform
- Maintenance-free battery
- Lithium battery
- GPS

(Note:* Max. drivable height for AS1413E is 8m outdoor use)

Machines in compliant with EN280 / ANSI 92.20 Standard.

Specifications subject to change without notice. Photos and diagrams in the page are for promotional purposes only. 2020 V1 Version

LINGONG GROUP JINAN HEAVY MACHINERY CO., LTD.

Address: No. 2676, Kejia Road, Jinan, Shandong, China
Email: sales@lgmg.com.cn Tel: +86-0531-67879283

LGMG Europe B.V.

Address: Laanweg 16 3208LC Spijkenisse Rotterdam, The Netherlands

LGMG North America, Inc.

Address: 1445 Sheffler Dr, Chambersburg, PA. 17201, USA



RELIABILITY IN ACTION