

# SX-015 Personal Step

**“The Compact, Safe, Time Saver.”**

**SX-015 can be easily moved for continuous operations at various height and increases operational efficiency.**

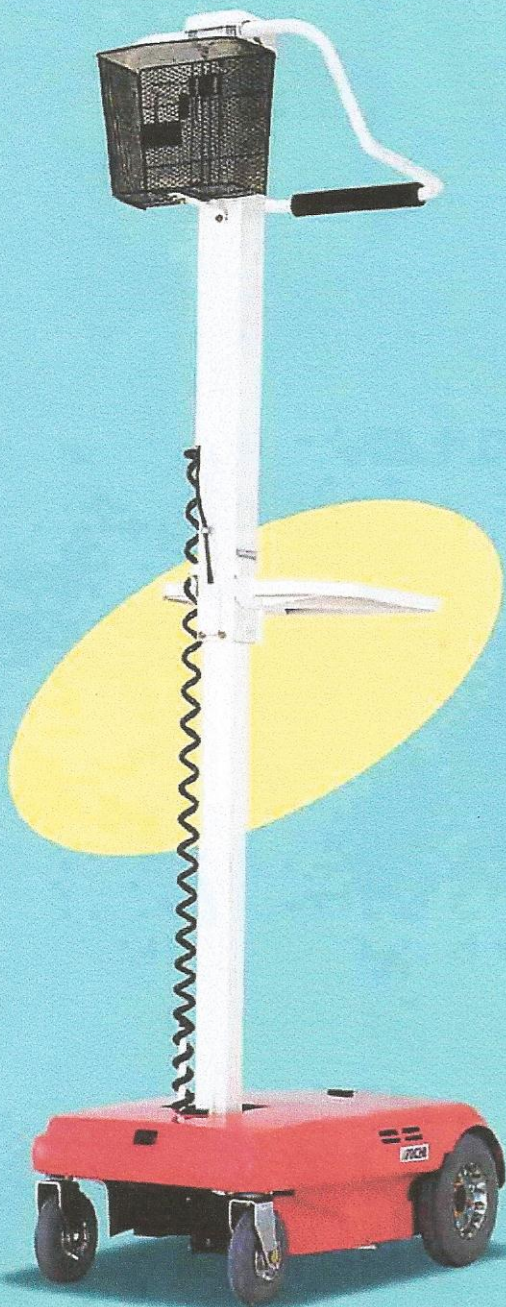
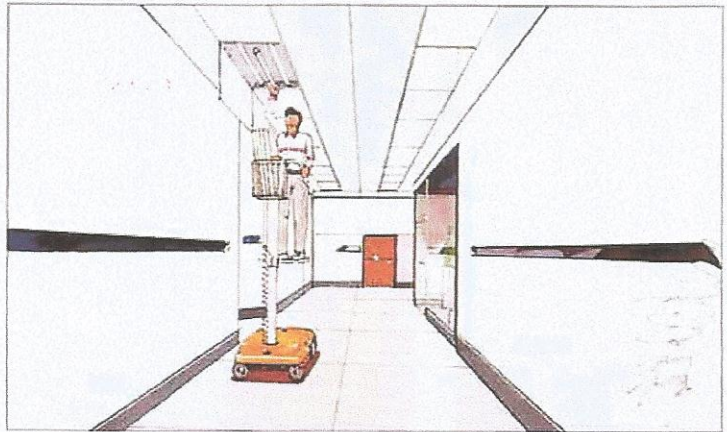
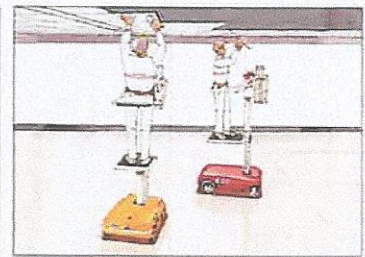
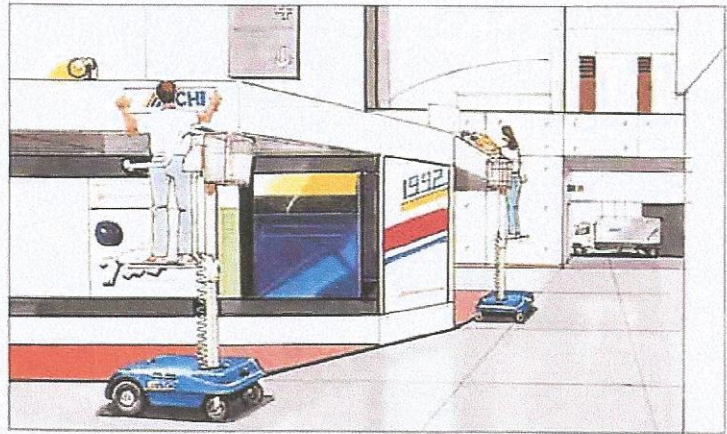

## SX-015

- Working Height  
9.8-11.5 ft (3-3.5 m)
- Load Capacity  
220 lbs (100 kg)

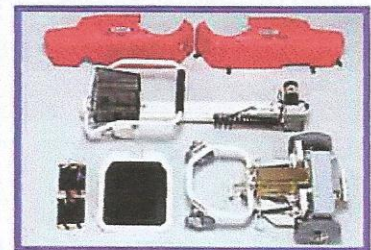



## STANDARDS FEATURES

### Easy Operation

A single control lever is utilized for all directional maneuvering. Travel is variable into three speeds automatically-low, medium & high. The lower speed is engaged when elevating the platform for safety.

### Smooth Platform Elevating & Lowering

The platform tower assembly actuates up & down effortlessly, enhancing the positioning of work on any job site.

### Serviceability

The SX-015 utilizes a maintenance free battery that can be quickly recharged via a standard, household, wall socket.

### Compact Size & Space Age Design

The SX-015 can maneuver in the tightest spaces and travel in elevators that our competitors dream about matching.

### Transportability

The SX-015 can be fully disassembled into 5 components within 6-8 minutes. It can then be loaded into the trunk of a medium sized car. Try beating that for job site versatility !

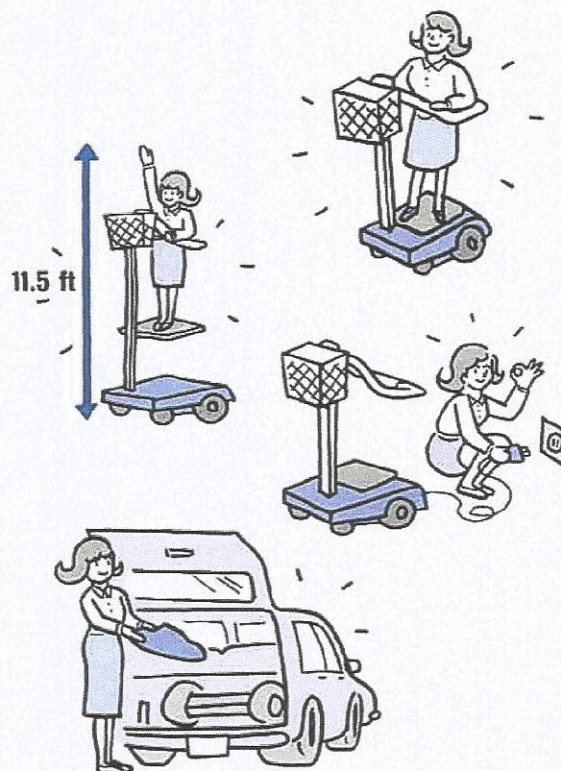

## TECHNICAL SPECIFICATIONS

- Working Height 9.8-11.5 ft (3-3.5m)
- Platform Height 4.9 ft (1.5m) (Fully extended)
- Overall Length 3.6 ft (1,090mm)
- Overall Width 2.3 ft (680mm)
- Overall Height 5.5 ft (1,660mm) (Retracted)
- Load Capacity 220 lbs (100kg)
- Operational Weight 287 lbs (130kg)
- Turning Radius 3ft (900mm)
- Travel Speeds 2.2(high) 1.7(med.) 1.0(low) mile/h  
(3.5(high) 2.7(med.) 1.6(low) km/h)

※ All specifications and designs contained in this catalog are subject to change without notice due to modifications and improvements.

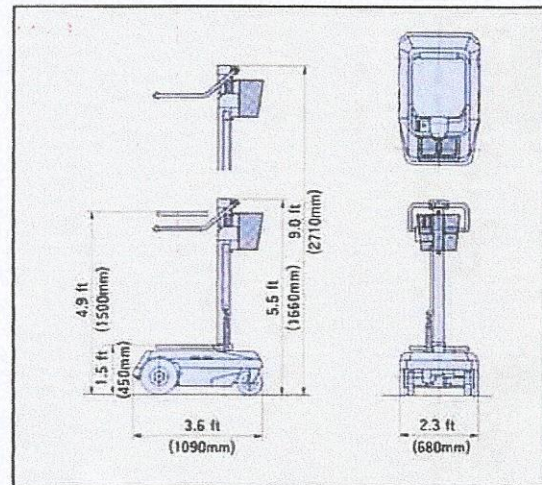

### AICHI CORPORATION

#### International Division

1152, Ryoike, Ageo,  
Saitama 362, JAPAN  
TEL:+81-48-781-1671  
FAX:+81-48-781-1808

#### For details contact

#### New Zealand. H.O.

Terry Stewart  
TEL:+64 (3) 4862333  
FAX:+64 (3) 4862334  
Old Main Rd, Henley  
1RD, Outram, New Zealand.

#### America

Alastair Robertson  
TEL:+1 (708) 8580522  
FAX:+1 (708) 8580520  
330 Prospect Ave.  
Glen Ellyn, ILL60137, U.S.A.

#### Europe

Mike Pitt  
TEL:+441934811019  
FAX:+441934811029  
P.O.Box124  
Western Super Mare, Avon, England